

UNCONTROLLED DOCUMENT

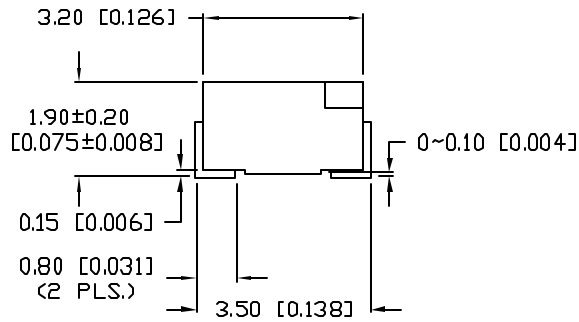

LEAD FREE REFLOW PROFILE

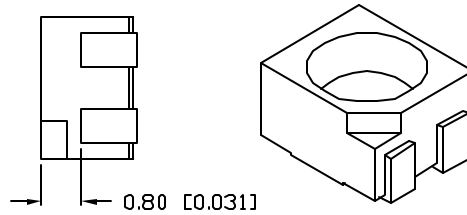
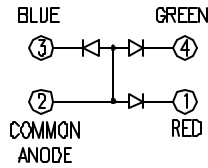
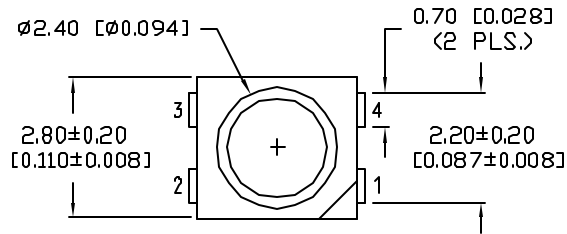
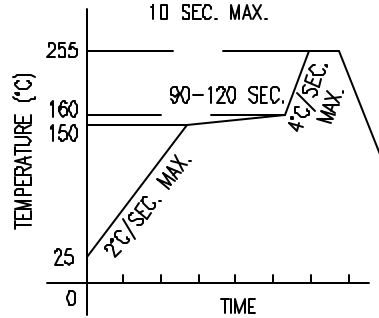

TOTAL TIME ABOVE 220°C IS 60 SECONDS MAX.

RECOMMENDED SOLDER PAD LAYOUT

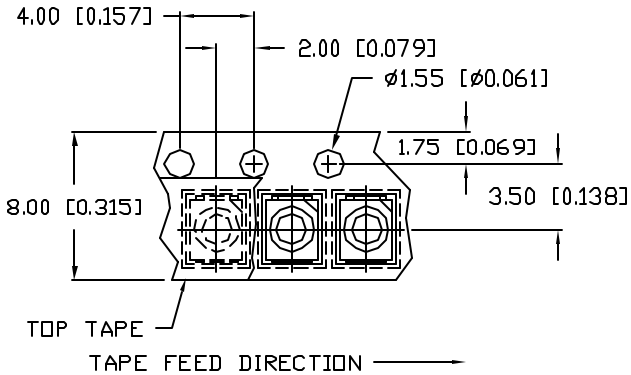
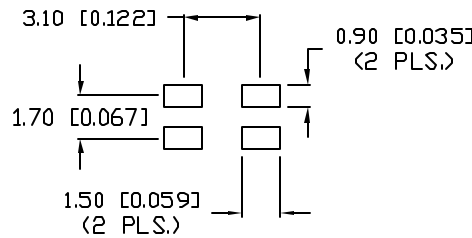

PART NUMBER		REV.
SML-LX2832SISUGSBC		B
REV.	E.C.N. NUMBER AND REVISION COMMENTS	DATE
A	E.C.N. #10967.	3.14.03
B	E.C.N. #11148.	6.5.05

ELECTRO-OPTICAL CHARACTERISTICS  $T_A=25^\circ\text{C}$   $I_f=20\text{mA}$

PARAMETER	RED	GREEN	BLUE	UNITS	TEST COND
PEAK WAVELENGTH	636	574	430	nm	
FORWARD VOLTAGE (TYP.)	2.0	2.2	3.5	$V_f$	
FORWARD VOLTAGE (MAX.)	2.4	2.6	4.5	$V_f$	
REVERSE VOLTAGE	5.0	5.0	5.0	$V_r$	$I_f=100\mu\text{A}$
AXIAL INTENSITY	80	60	60	mcd	$I_f=20\text{mA}$
VIEWING ANGLE	120	120	120	2x theta	
LED POSITION:	1	2	3		
EPOXY LENS FINISH: WATER CLEAR					

LIMITS OF SAFE OPERATION AT 25°C PER CHIP

PARAMETER	COLORS	MAX	UNITS
PEAK FORWARD CURRENT*	(R/G/B)	160/160/100	mA
STEADY CURRENT	(R/G/B)	25/25/30	mA
POWER DISSIPATION		120	mW
DERATE FROM 25°C		-1.2	mW/°C
OPERATING TEMP.		-40 TO +85	°C
STORAGE TEMP.		-40 TO +85	°C

\*  $t < 10\mu\text{s}$

NOTES:

- THE POLARITY MARK IS ORIENTED TOWARDS THE TAPE SPROCKET HOLE.

CAUTION: STATIC SENSITIVE DEVICE  
FOLLOW PROPER E.S.D. HANDLING PROCEDURES  
WHEN WORKING WITH THIS PART.

CAUTION: MOISTURE SENSITIVE DEVICE  
PER JEDEC LEVEL 4 STANDARDS

UNCONTROLLED DOCUMENT

\*UNLESS OTHERWISE SPECIFIED TOLERANCES PER DECIMAL PRECISION ARE: X=±1 (±0.039), XX=±0.5 (±0.020), XXX=±0.25 (±0.010), XXXX=±0.127 (±0.005). LEAD SIZE=±0.05 (±0.002), LEAD LENGTH=±0.75 (±0.030), MIN=+0.00/-0.00, MAX.=+0.00/-0.00

REV. B	PART NUMBER SML-LX2832SISUGSBC	CONFIDENTIAL INFORMATION THE INFORMATION CONTAINED IN THIS DOCUMENT IS THE PROPERTY OF LUMEX INC. EXCEPT AS SPECIFICALLY AUTHORIZED IN WRITING BY LUMEX INC, THE HOLDER OF THIS DOCUMENT SHALL KEEP ALL INFORMATION CONTAINED HEREIN CONFIDENTIAL AND SHALL PROTECT SAME IN WHOLE OR IN PART FROM DISCLOSURE AND DISSEMINATION TO ALL THIRD PARTIES.	290 E. HELEN ROAD PALATINE, IL 60067-6976 PHONE: +1.847.359.2790 US WEB: www.lumex.com TW WEB: www.lumex.com.tw
2.8mm x 3.2mm SURFACE MOUNT WITH REFLECTOR CUP, SUPER INTENSITY RED, SUPER ULTRA GREEN, SUPER BLUE, WATER CLEAR LENS, TAPE AND REEL		RELIABILITY NOTE OUR MANY YEARS OF EXPERIENCE DATA ACCUMULATION INDICATE THAT SOLDER HEAT IS A MAJOR CAUSE OF EARLY AND FUTURE FAILURE. PLEASE PAY ATTENTION TO YOUR SOLDERING PROCESS.	DRAWN BY: GB CHECKED BY: APPROVED BY: DATE: 6.4.02 PAGE: 1 OF 1 SCALE: N/A